

Miscelatori incasso

Concealed mixers

Einbau-Mischbatterien

Ø40

Differenti possibilità di miscelatori da incasso, dal semplice corpo doccia fino alla combinazione con deviatori click-clack e a pulsante a 2 vie; ceramici a 2/3 vie per un'ampia gamma di soluzioni.

Different possibilities of built-in mixers, from the simple shower body to the combination with click-clack diverters and 2-way push-button; 2/3-way ceramic for a wide range of solutions.

Verschiedene Möglichkeiten der Einbaumischer, vom einfachen Duschkörper bis hin zur Kombination mit Klick-Klack-Umstellern und 2-Wege-Drucktaster; 2/3-Wege Keramik für ein breites Spektrum an Lösungen.

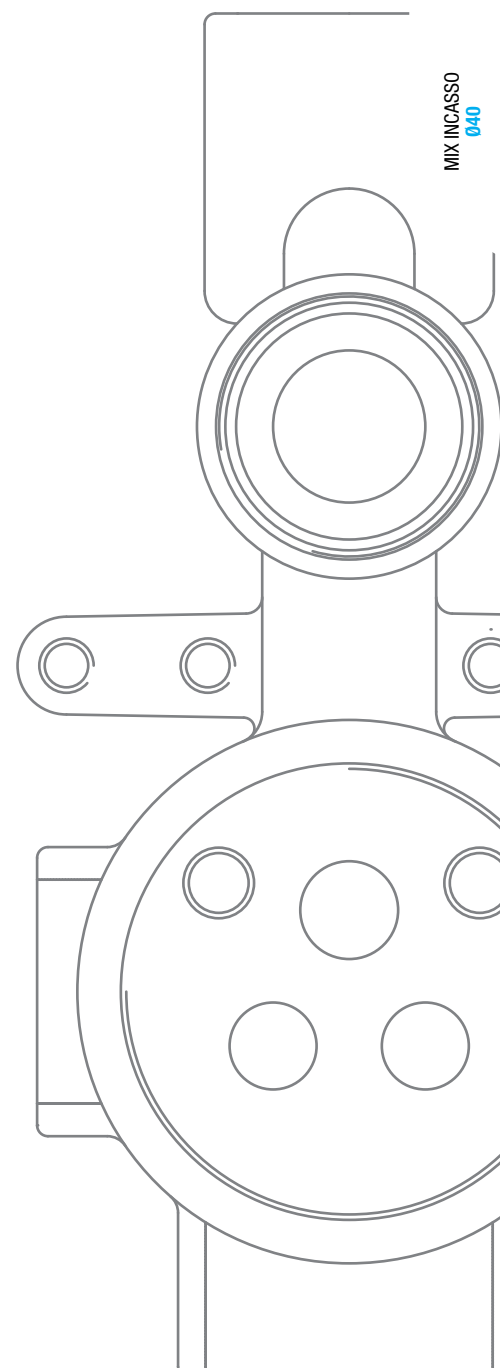

Miscelatore lavabo / doccia incasso
 Concealed basin / shower mixer
 Einbau-Mischbatterie für Waschtische / Duschen

Ø40

uscita laterale
 side exit
 Seitenausgang

Diagramma di portata
 (uscita libera)
 Flow diagram
 (free exit)
 Diagramm der
 Durchflussleistung
 (freier Ausgang)

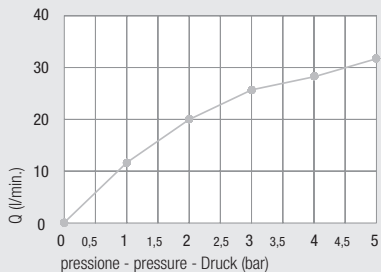

Piastre idonee - *Appropriate plates* - Passende Platten pag. 108



Art. 1194...



Art. 1198...



Art. 1002...



Art. 1235CA



Art. 1050CA...

Art. 1174

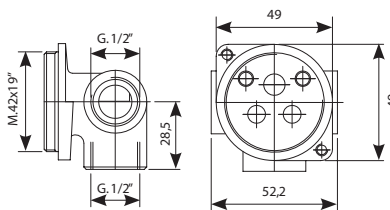

Con bicchiere
 With cartridge ring seat
 Mit Kartuschenringsitz



con con bicchiere - with cartridge ring seat

Art. 2174

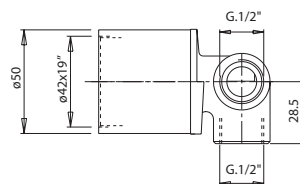

INSTALLATION Art. 3184 page 154

Art. 1161

Anello sede cartuccia
 Cartridge ring seat
 Kartuschenringsitz



Art. 1501

Ghiera serraggio
 Ring nut
 Gewindeverschraubung



Art. 1500

Cappuccio ABS
 ABS cap
 ABS-Kappe



Art. 600

Kit prolunga sede cartuccia
 Extension kit for cartridge seat
 Verlängerungsbausatz Kartuschensitz

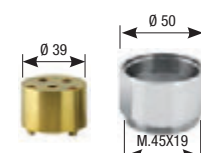

uscita superiore
upper exit
oberer Ausgang

uscita inferiore
lower exit
unterer Auslauf

Art.1160

DZR
Available

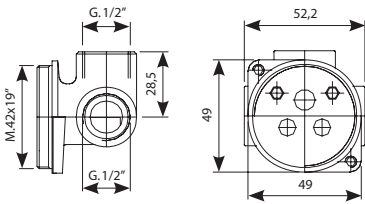
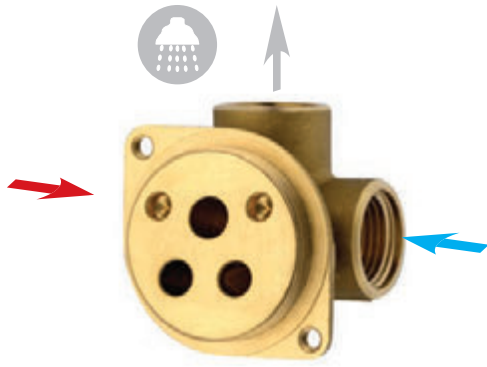

Art. 1160-180

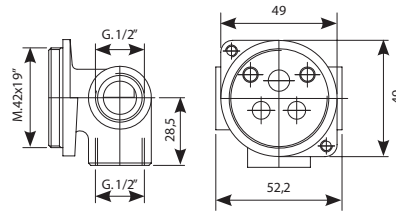
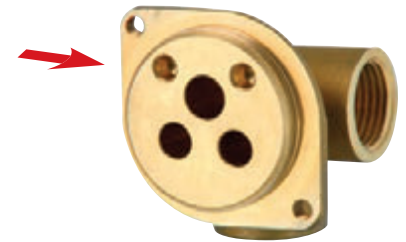

mit Kartuschenringsitz

Art. 1170

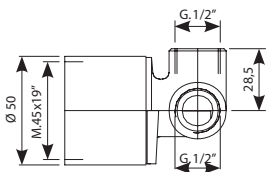

Art. 1170-180

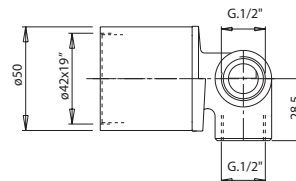

Art. 3184

Scatola di assemblaggio
Multipurpose assembling box
Montagegehäuse

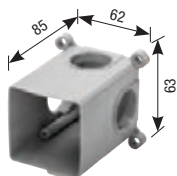

Art. 3184ME

Membrana isolante
Insulating membrane
Isolierungsmembran

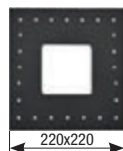

Art. 3181G1/2

Guarnizione G.1/2"
Gasket G.1/2"
Dichtung mit 1/2"-Drehung



Art. 3187

Coperchio scatola
Box cover
Gehäuseabdeckung

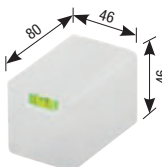

Art. PR50

Protezione mix
Mix protection
Schutzvorrichtung Mixer



Art. 3185

Prolunga G.1/2"
Extension G.1/2"
Verlängerung mit 1/2"-Drehung



Miscelatore **vasca** incasso

Concealed **bath** mixer

Einbau-Mischbatterie für **Badewannen**



Diagramma di portata
(uscita libera)
Flow diagram
(free exit)
Diagramm der
Durchflussleistung
(freier Ausgang)

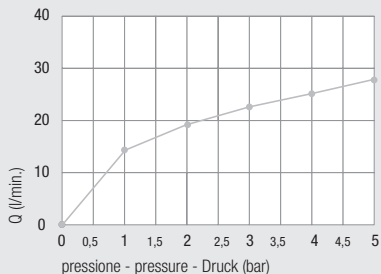

Piastre idonee - *Appropriate plates* - Passende Platten pag. 108



Art. 1183...



Art. 1193/P...



Art. 1193...



Art. 1187



Art. 1040CA...

Design



Art.Q

Versione quadrata
Square version
Quadratische Ausführung



Art.MN

Versione minimal ottone cromato o ABS
Minimal design version brass-chrome or ABS
Minimalistische Ausführung Verchromtes Messing oder ABS

con deviatore **click-clack**
with click-clack diverter
mit **click-clack**



con deviatore a pulsante
with push diverter
mit **Druckknopfumstellung**

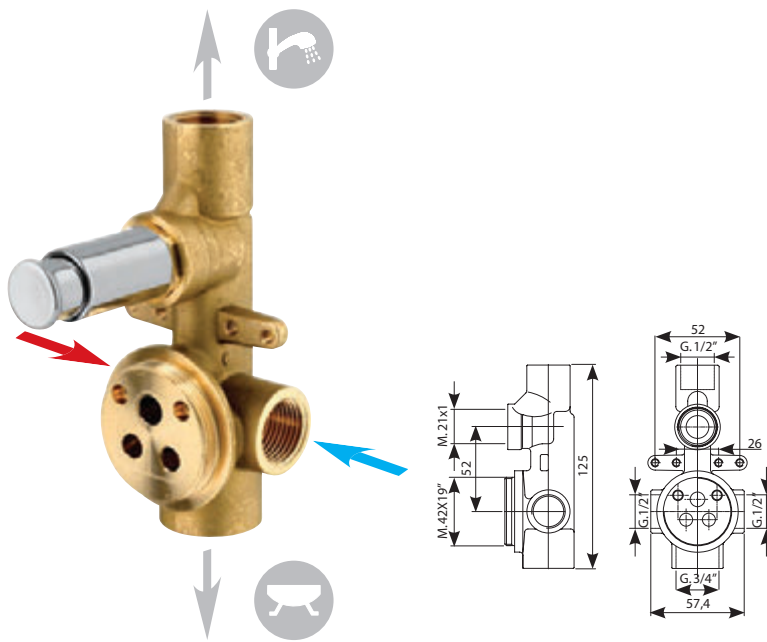

(Art. 1502 KS)



Art. 1180 K

(Art. 1502)



Art. 1180

INSTALLATION Art. 3181CG page 160

Art. 1161

Anello sede cartuccia
Cartridge ring seat
Kartuschenringsitz



Art. 1501

Ghiera serraggio
Ring nut
Gewindeverschraubung



Art. 1500

Cappuccio ABS
ABS cap
ABS-Kappe



Art. 600

Kit prolunga sede cartuccia
Extension kit for cartridge seat
Verlängerungsbausatz Kartuschenringsitz

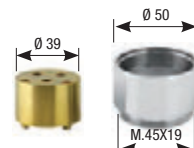

Ø40

2 exits

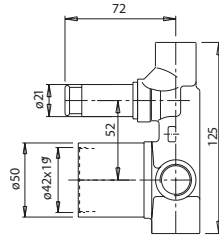

Con bicchiere
With cartridge ring seat
Mit Kartuschenringsitz

Art. 1190 K

Art. 1190

Art. 610
Prolunga deviatore
Diverter extension
Verlängerung Umstellventil

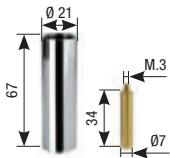

Art. PR50
Protezione mix
Mix protection
Schutzvorrichtung Mixer



Art. PR20
Protezione in plastica
Plastic protection
Kunststoffschutzvorrichtung



Art. 3181CG
Scatola di assemblaggio
Multipurpose assembling box
Montagegehäuse

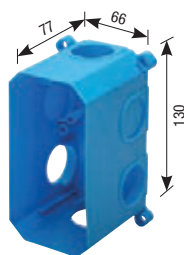

Art. 3181ME
Membrana isolante
Insulating membrane
Isolierungsmembran

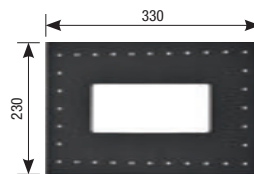

Art. 3183
Coperchio scatola
Box cover
Gehäuseabdeckung



Art. 3181G1/2
Guarnizione G. 1/2"
Gasket G. 1/2"
Dichtung mit 1/2"-Drehung



Art. 3181G3/4
Guarnizione G. 3/4"
Gasket G. 3/4"
Dichtung mit 3/4"-Drehung

Art. 3185
Prolunga G. 1/2"
Extension G. 1/2"
Verlängerung mit 1/2"-Drehung

Art. 3186
Prolunga G. 3/4"
extension G. 3/4"
Verlängerung mit 3/4"-Drehung



Miscelatore doccia incasso

Concealed shower mixer

Einbau-Mischbatterie für Duschen



Diagramma di portata (uscita libera)
Flow diagram (free exit)
Diagramm der Durchflussleistung (freier Ausgang)

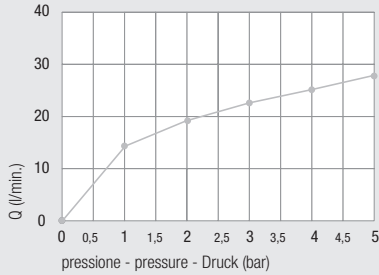

Piastre idonee - Appropriate plates - Passende Platten pag. 108



Art. 1183...



Art. 1193/P...

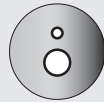

Art. 1193...



Art. 1187



Art. 1040CA...

Design



Art.Q
Versione quadrata
Square version
Quadratische Ausführung



Art.MN
Versione minimal ottone cromato o ABS
Minimal design version brass-chrome or ABS
Minimalistische Ausführung Verchromtes Messing oder ABS

con deviatore **click-clack**
with **click-clack** diverter
mit **click-clack**



con deviatore a pulsante
with **push** diverter
mit **Druckknopf**umstellung

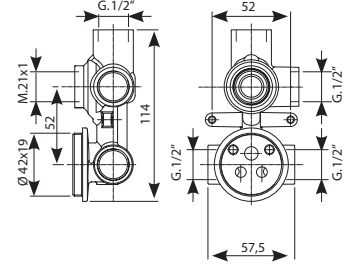
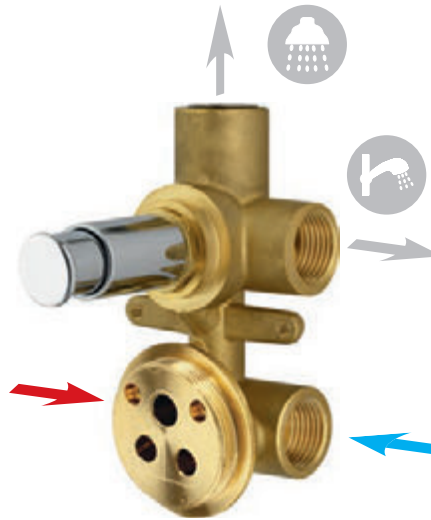

(Art. 1502 KS)



Art. 2182 K

(Art. 1502)



Art. 2182

INSTALLATION Art. 3182CG page 164

Art. 1161
Anello sede cartuccia
Cartridge ring seat
Kartuschenringsitz



Art. 1501
Ghiera serraggio
Ring nut
Gewindeverschraubung



Art. 1500
Cappuccio ABS
ABS cap
ABS-Kappe



Art. 600
Kit prolunga sede cartuccia
Extension kit for cartridge seat
Verlängerungsbausatz Kartuschenring

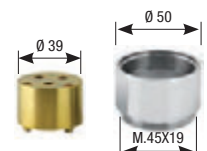

Ø40

2 exits

Con bicchiere
With cartridge ring seat
Mit Kartuschenringsitz

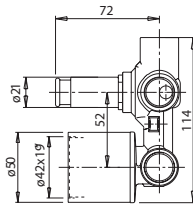

Con bicchiere
With cartridge ring seat
Mit Kartuschenringsitz

Art. 2192 K

Art. 2192

Art. 610
Prolunga deviatore
Diverter extension
Verlängerung Umstellventil

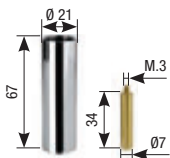

Art. PR20
Protezione in plastica
Plastic protection
Kunststoffschutzvorrichtung



Art. 3181ME
Membrana isolante
Insulating membrane
Isolierungsmembran

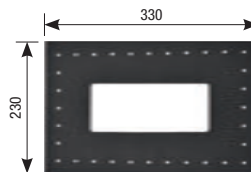

Art. 3181G1/2
Guarnizione G.1/2"
Gasket G.1/2"
Dichtung mit 1/2"-Drehung



Art. PR50
Protezione mix
Mix protection
Schutzvorrichtung Mixer



Art. 3182CG
Scatola di assemblaggio
Multipurpose assembling box
Montagegehäuse

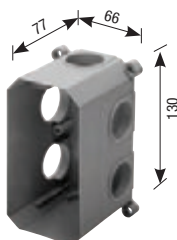

Art. 3183
Coperchio scatola
Box cover
Gehäuseabdeckung



Art. 3185
Prolunga G.1/2"
Extension G.1/2"
Verlängerung mit 1/2"-Drehung



Miscelatore **doccia** incasso
Concealed shower mixer
 Einbau-Mischbatterie für **Duschen**



Diagramma di portata
(uscita libera)
 Flow diagram
(free exit)
 Diagramm der
Durchflussleistung
(freier Ausgang)

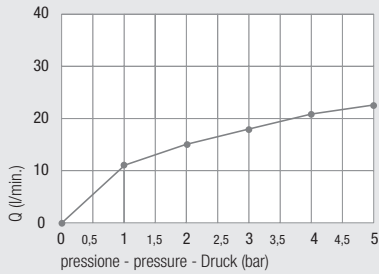

Piastre idonee - *Appropriate plates* - Passende Platten pag. 108



Art. 1183...



Art. 1193/P...



Art. 1193...



Art. 1187



Art. 1040CA...

con deviatore **ceramico**
with ceramic diverter
 Keramik-Umstellventil



Art. 2001/90FA



Art. 2182CER

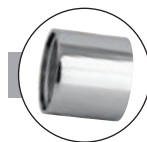
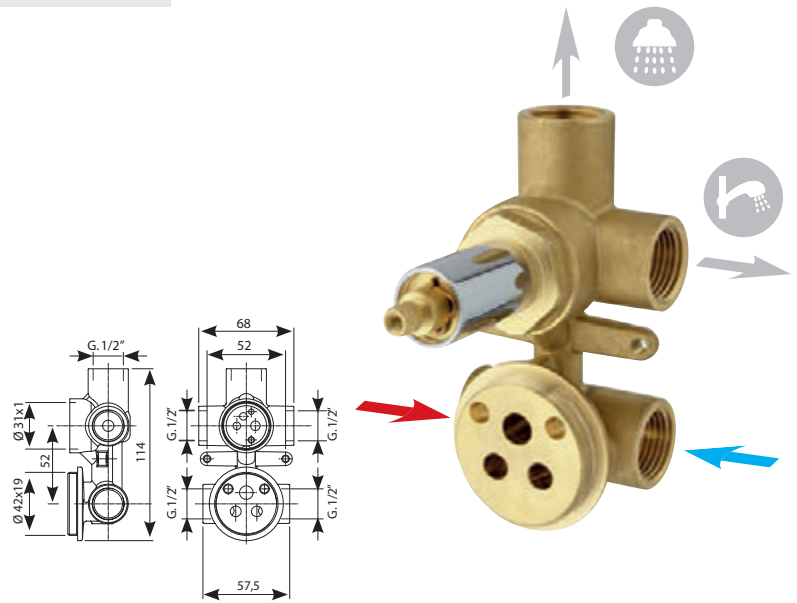

con con bicchiere - *with cartridge ring seat*

Art. 2192CER

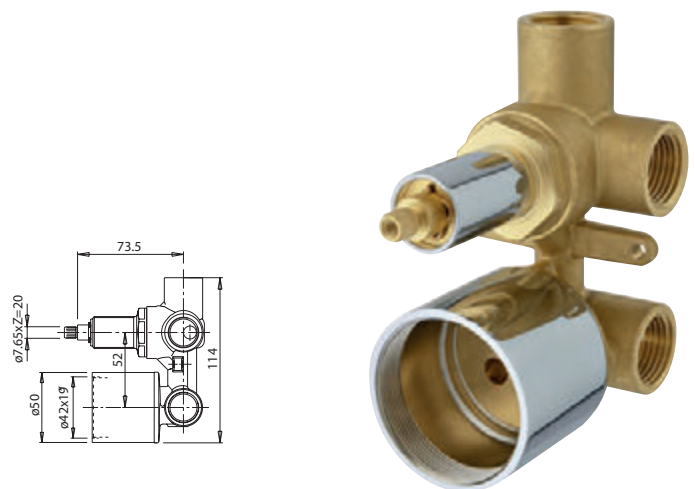

con deviatore **ceramico**
with **ceramic diverter**
Keramik-Umstellventil



Art. 2001FA

Art. 2180CER

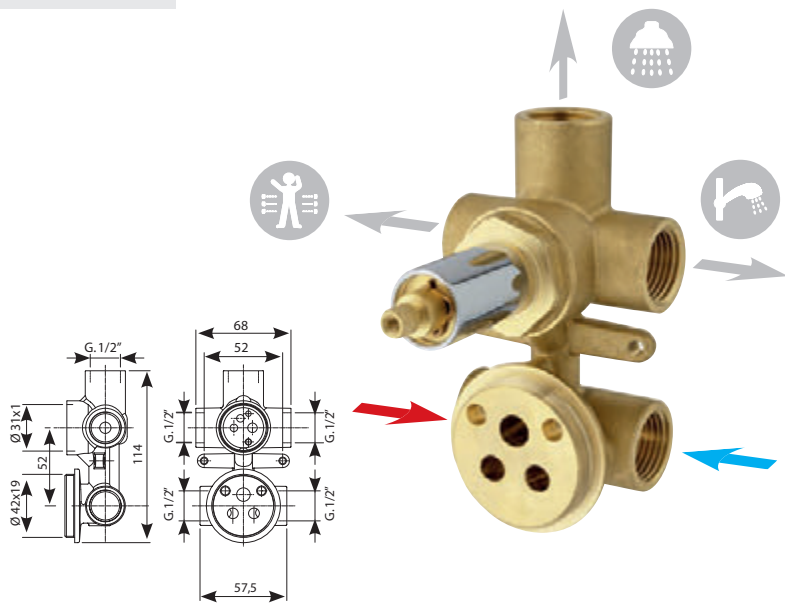

mit Kartuschenringsitz

Art. 2190CER

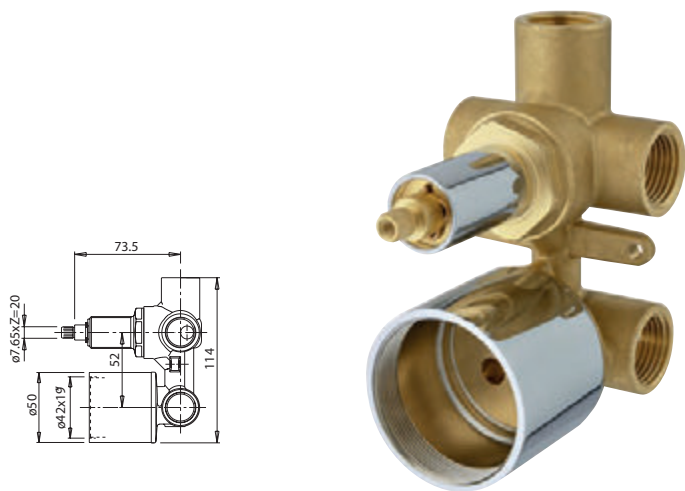

Art. 1161

Anello sede cartuccia
Cartridge ring seat
Kartuschenringsitz



Art. 1500

Cappuccio ABS
ABS cap
ABS-Kappe



Art. 1501

Ghiera serraggio
Ring nut
Gewindeverschraubung



Art. 600

Kit prolunga sede cartuccia
Extension kit for cartridge seat
Verlängerungsbausatz Kartuschensitz

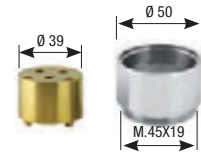

Art. 630

Prolunga deviatore
Diverter extension
Verlängerung Umstellventil

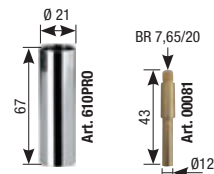

Art. 00122

Maniglia deviatore
Diverter handle
Umstellgriff

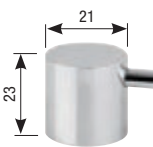

Art. 1502PRO

Coprifiletto deviatore cromato
Diverter cover thread
Verchromte Gewindeabdeckung Umstellventil

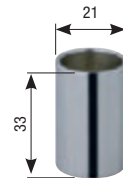

Art. PR50

Protezione mix
Mix protection
Schutzvorrichtung Mixer



Art. PR20

Protezione in plastica
Plastic protection
Kunststoffschutzvorrichtung



Art. 3182CG

Scatola di assemblaggio
Multipurpose assembling box
Montagegehäuse

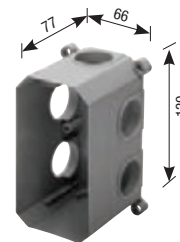

Art. 3183

Coperchio scatola
Box cover
Gehäuseabdeckung



Art. 3181ME

Membrana isolante
Insulating membrane
Isolierungsmembran

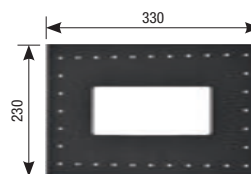

Art. 3185

Prolunga G. 1/2"
Extension G. 1/2"
Verlängerung mit 1/2"-Drehung



Art. 3181G1/2

Guarnizione G. 1/2"
Gasket G. 1/2"
Dichtung mit 1/2"-Drehung



Miscelatore incasso pannello doccia

Concealed mixer for shower panel

Einbau-Mischbatterie für Duschpaneel

Ø40

DZR
Available

Diagramma di portata
(uscita libera)

Flow diagram
(free exit)

Diagramm der
Durchflussleistung
(freier Ausgang)

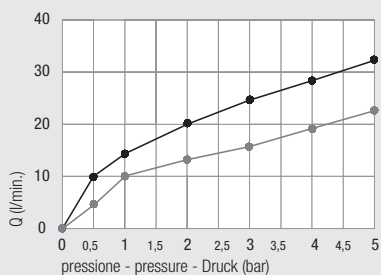
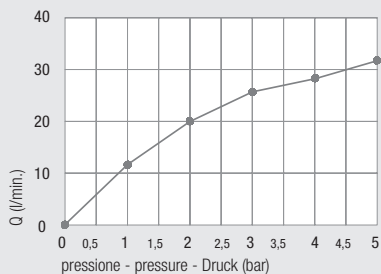

Design



Art.Q

Versione quadrata
Square version
Quadratische Ausführung



Art.MN

Versione minimal ottone cromato o ABS
Minimal design version brass-chrome or ABS
Minimalistische Ausführung Verchromtes Messing oder ABS

Art. 1173

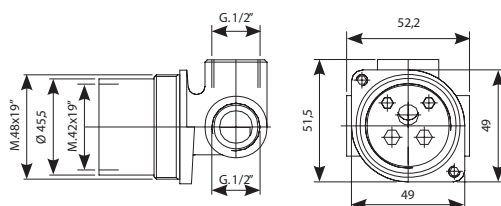
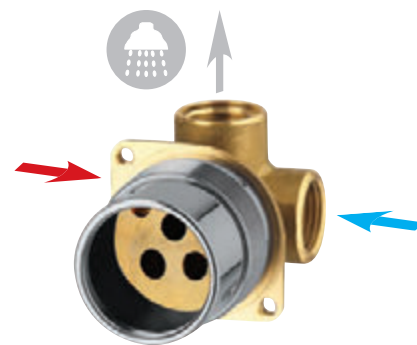

Art. 1190/BOX

2 exits

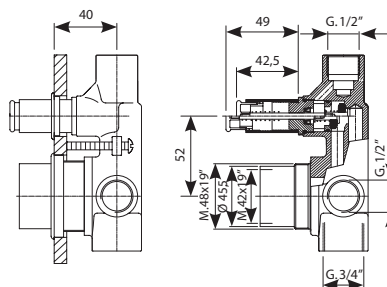

Art. 1048
Cappuccio ABS
ABS cap
ABS-Kappe



Art. 1610
Ghiera
Ring nut
Gewindehülse

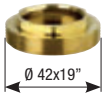

Art. 2005
Viti di fissaggio
Fastening screws
Befestigungsschrauben
M.5 L=50

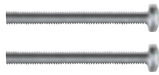

Art. 2007
Anello di fissaggio cromo
Fastening ring chrome
Befestigungsring aus Chrom

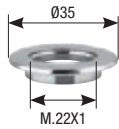

Art. GHSUP48
Ghiera superiore
Upper nut
Obere Gewindehülse

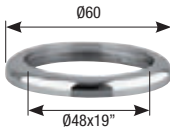

Art. GHINF48
Ghiera inferiore
Lower nut
Untere Gewindehülse

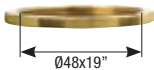

Art. 1014
Anello sede cartuccia
Cartridge ring seat
Kartuschenringsitz



Art. PR20
Protezione in plastica
Plastic protection
Kunststoffschutvorrichtung



Art. PR45
Protezione mix
Mix protection
Schutvorrichtung Mixer

